



TRAILSIDE

A HARTFORD COMMUNITY

DESIGN GUIDELINES
NOVEMBER 2022

Trailside Metropolitan District



TABLE OF CONTENTS:

1.0 INTRODUCTION	4
1.1 Purpose of these Guidelines	
1.2 Community Vision	
1.3 Relationship to other plans and criteria	
1.4 Design Review Committee	
2.0 LAND USE	7
2.1 Land Use Plan	
3.0 ARCHITECTURAL CHARACTER	8
3.1 General Character & Product Types	
3.1.1 Traditional Single Family	
3.1.2 Alley-loaded Single Family with Side Yard Use Easements	
3.1.3 Paired Patio	
3.1.4 Townhomes	
3.1.5 Condominiums / Apartments	
3.1.6 Typical Improvements	
4.0 LANDSCAPE STANDARDS	16
4.1 Public / Open Space Landscape	
4.1.1 Parks	
4.1.2 Entryways & Edges	
4.1.3 Trail Corridors	
4.2 Private Landscapes	
4.2.1 General Landscape Requirements	
4.3 Side Yard Use Easements	
4.4 Landscape Lot Typicals, Maintenance, & Required Planting	
4.4.1 Single Family Detached Front and Side Load	
4.4.2 Single Family Detached Front Load/Pass-By	
4.4.3 Single Family Detached Rear Load	
4.4.4 Front Load Paired Homes	
4.4.5 Alley Loaded Paired Homes	
4.4.6 Townhomes	
4.5 Trailside Signature Plant List	
5.0 FENCING	34
5.1 Permitted Fencing	
5.1.1 Horizontal Wood Fence	
5.1.2 3-Rail Fence	
5.2 Fencing Setbacks	
5.3 Fence Stain	
5.4 Pet Areas	
6.0 SIGNAGE	38
6.1 Sign Locations	
6.2 Builder Signage	
6.3 Builder Sign - On Site & Model Home	

1.0 INTRODUCTION:

1.1 Purpose

These Design Guidelines are established to ensure the overall development quality is maintained during the final planning and design of Trailside, and maintained after design and construction. They are intended to promote design excellence by encouraging builders to explore and expand their range of architectural styles and methods when building residential products. These guidelines are intended to promote creativity and incorporate the flexibility necessary to achieve the diverse, yet cohesive community planned for Trailside. Creativity and excellence in design will be the primary criteria for receiving approvals during the design review process. The intent of these guidelines is not to provide prescriptive “standards” or “requirements” that will only impair the architect/builder from being able to achieve the high level of design desired for this community. Rather, these guidelines are meant to encourage excellence in design and are not intended to be interpreted as strict requirements.

1.2 Community Vision

Trailside is a new master-planned community incorporating a range of uses including but not limited to residential and commercial, trails, and a variety of parks and open spaces. One of the foundational ideas behind the Trailside plan is a diverse mix of residential housing within dynamic, walkable neighborhoods. Characterized by front porches, a variety of pocket parks and gathering spaces, the design of Trailside is intended to allow for serendipitous encounters that will foster individual relationships and a closer community.

To help make the community vision a reality, land use standards are in place to create a compact, walkable community with a diversity of housing types that are viable given current and anticipated housing trends. This generally means more compact lots with less private yard space to maintain, while simultaneously providing enhanced public open space for recreation. Modified roadway standards in Trailside serve to efficiently accommodate the integration of a range of residential lot types, sidewalks, trees lawns, vehicles, pedestrians, and bicyclists.

Six types of residential development are anticipated at Trailside including traditional front-loaded single-family lots, front-loaded pass-by lots, alley-loaded single-family lots, alley-loaded paired homes and townhomes, and multifamily/senior living. All alley-loaded product either front on streets or greenways.

1.3 Relationship to Other Plans and Criteria

These Design Guidelines serve as the basis for guiding each builder's proposal for architectural design of the structures and other lot improvements and ensuring conformance with the overall intent of the Trailside planned community.

These guidelines do not modify other applicable Federal, State, and local codes and ordinances, but should be used in conjunction with these regulations. Use of property and improvements to property must comply with applicable building codes and other governmental requirements and regulations.

Refer to the Trailside Planned Development Overlay for site-specific design standards.

1.4 Design Review Committee

All new development within Trailside is subject to review by the Design Review Committee (DRC) for conformance with these Design Guidelines as well as those set forth in the Master Declaration of Covenants, Conditions, and Restrictions (CC&R's) for the Trailside Metro District. Homeowners and Developers are strongly encouraged to meet with the DRC early in the design process to ensure conformance with the Trailside theming.

The review process will consist of the following:

- Concept Review
- Architectural Drawings and Specifications Review
- Landscape Plans Review
- A review fee may be required with each application.

For a more detailed look at the DRC design review process refer to Article 9 of the Trailside Metro District CC&R's.





2.0 LAND USE:

2.1 Land Use Plan

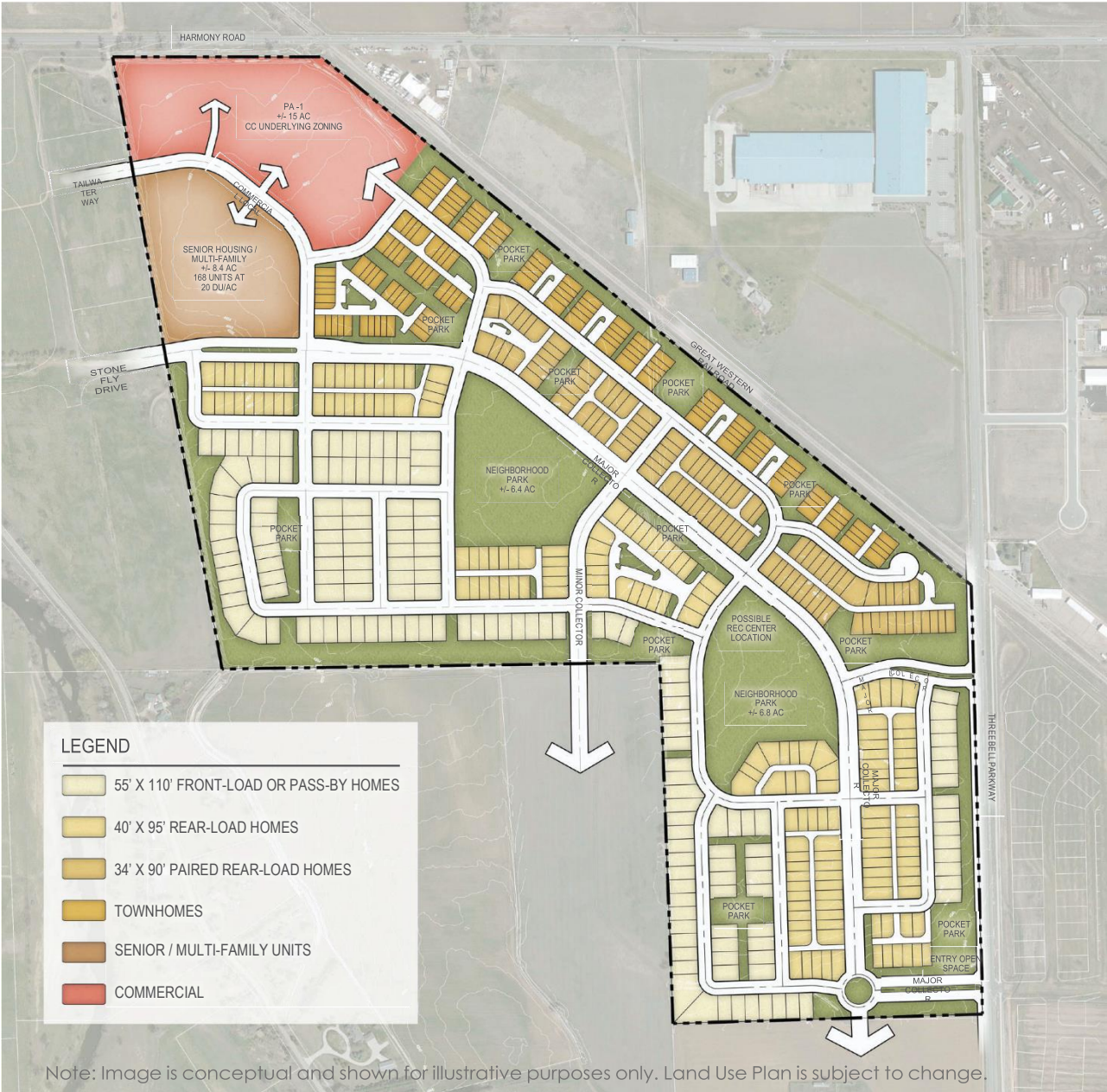

The Land Use Plan shows the conceptual design for Trailside, including the general arrangement of various housing types. Trailside includes traditional single family detached front-loaded homes, single family detached alley-loaded homes, paired rear-load homes, and townhomes, as well as a future multi-family or senior housing site. A small commercial parcel is situated just off Harmony Road and will be reviewed separately by the DRC for compliance with the guidelines. The neighborhood is designed around two large parks, to be designed, built, and maintained by the District. Trailside also includes ten additional pocket parks and a series of interconnected trails that connect the Cache La Poudre Trail.

3.0 ARCHITECTURAL CHARACTER:

3.1 GENERAL CHARACTER & PRODUCT TYPES

Architectural styles shall be Colorado vernacular, possibly including but not limited to Craftsman, Prairie, Farmhouse, and Contemporary Transition (this includes contemporary versions of the previous styles). Present day interpretations of traditional styles are encouraged. Homes should be different than, but compatible with, the neighboring homes. Duplicate floor plans, elevations, and color scheme shall not be allowed on adjacent lots or on lots across the street from each other. Building mass should provide interest and depth. Refer to pg. 3 of the approved Planned Development Overlay for lot diversity standards.

The photos shown below are for illustrative purposes only and do not necessarily reflect the final design of the homes at Trailside.

3.2 TRADITIONAL SINGLE FAMILY

1. A variety of architectural styles are permitted, including craftsman, farmhouse, prairie, or other styles.
2. Primary body colors will be subtle earth tones, including, but not limited to, blues, grays, browns, taupes, and greens.
3. Color transitions/changes will be used to highlight changes in massing, form, and materials.
4. Bold, vibrant colors will be used in limited and select accent areas (e.g., front doors).
5. No adjacent buildings will utilize similar color schemes.



3.3 ALLEY-LOADED SINGLE FAMILY (WITH OR WITHOUT SIDE YARD USE EASEMENTS)

1. A variety of architectural styles are permitted, including craftsman, farmhouse, prairie, or other styles.
2. Primary body colors will be subtle earth tones, including, but not limited to, blues, grays, browns, taupes, and greens.
3. Color transitions/changes will be used to highlight changes in massing, form, and materials.
4. Bold, vibrant colors will be used in limited and select accent areas (e.g., front doors).
5. No adjacent buildings will utilize similar color schemes.



3.4 PAIRED HOMES

1. A variety of architectural styles are permitted, possibility including craftsman, farmhouse, prairie, or other styles.
2. Primary body colors will be subtle earth tones, including, but not limited to, blues, grays, browns, taupes, and greens.
3. Color transitions/changes will be used to highlight changes in massing, form, and materials.
4. Bold, vibrant colors will be used in limited and select accent areas (e.g., front doors).
5. No adjacent buildings will utilize similar color schemes.



3.5 TOWNHOMES

1. Primary body colors will be subtle earth tones, including, but not limited to, blues, grays, browns, taupes, and greens.
2. Color transitions/changes will be used to highlight changes in massing, form, and materials.
3. Bold, vibrant colors will be used in limited and select accent areas (e.g., front doors).
4. No adjacent buildings will utilize similar color schemes.



3.6 APARTMENTS/SENIOR HOUSING/ MULTI-FAMILY

1. Apartments are permitted within Trailside in the locations indicated in the land use plan map.
2. Any condominiums or apartments will be designed with a character that is complementary to the overall character of Trailside.



3.7 TYPICAL IMPROVEMENTS

The following list contains a wide variety of typical types of improvements which homeowners frequently consider installing. Unless otherwise specifically stated, drawings and/or plans for a proposed improvement must be submitted to the DRC and written approval of the DRC obtained PRIOR TO commencement of construction of the improvement. If a proposed improvement is not specifically listed below, the homeowner, architect, builder, or landscape designer must still make a request to the DRC for review and approval. Again, make sure the most current revision of the guidelines are being used, as they can change from time to time as allowed by the Trailside Conditions, Covenants, and Restrictions (CC&R's). Also, submittal fees may be adjusted from time to time by the DRC. DRC approval is required for, but is not limited to, the following typical improvements:

- 1) **ACCESSORY BUILDINGS and STORAGE BUILDINGS.** Accessory buildings must be constructed to closely match the design, colors, materials and overall character of the residence. Maximum size allowed shall be 60 square feet. Windows and articulation are highly encouraged, as are changes in roof planes. The DRC will base approval on the complementary nature of the building as it relates to the residence. The structure will be located on the lot so not to obstruct the views of other residents. If possible the overhead door(s) should not face the street. The wall(s) facing the street should contain windows similar to the house. Should conflict occur between these Design Guidelines and the PDO, the PDO takes precedence.
- 2) **ADDITIONS and EXPANSIONS.** They will be considered if they look like an integral part of the residence, rather than "tacked on" or an "after thought".
- 3) **ADVERTISING.** See "SIGNS".
- 4) **AIR CONDITIONING EQUIPMENT.** Only central air conditioning is permitted. Air conditioning equipment must be installed only in a side or rear yard and should be reasonably screened from view of adjacent property owners. Installation of air conditioning equipment on the roof, in a window, or through the wall of a residence is not permitted.
- 5) **ANTENNAE.** Not permitted. Exterior radio (including amateur "ham" radio), television, or other types of antennae may not be erected. (See Satellite Antenna/Dish)
- 6) **AWNINGS.** Type and location require DRC approval. The color must be similar or complementary to the exterior color of the residence. The covering may be used over the rear patio only. No aluminum or fiberglass awnings are allowed.
- 7) **BALCONIES.** See "DECKS" and "PATIOS".

8) BASKETBALL BACKBOARDS. DRC approval is required for placement and design.

9) BIRD HOUSES and FEEDERS. DRC approval is not required if limited to 1-foot by 2-feet and if not more than two in number are installed on any lot. They must be located within the front or back yards, but not within 10 feet of the side and/or back property lines. This also applies to bird baths.

10) CARPORT. Carports are not permitted.

11) CLOTHES LINES AND HANGERS. Clothes lines are not permitted unless they are the totally retractable type. The device must be attached to the rear elevation of the house in an obscure location. The device must be in the fully retracted position at all times unless being used. The use of the device is limited to occasional temporary use.

12) COLORS. Main body colors should be subtle earth tones, including browns, greens, grays, taupes, etc.; however, accents of more vibrant/urban colors may be used in select areas. All colors and color combinations must be approved by the DRC PRIOR TO their application. DRC approval, when existing color changes, requires DRC approval. All projections including, but not limited to, chimney flues, vents, gutters, downspouts, utility boxes, porches, railing, and exterior stairways shall be of an approved color and shall closely match or complement the permanent color of the surface from which they project. Duplicate color schemes shall not be allowed on adjacent lots or on lots across the street from each other. Bold colors may be used only with written approval of the DRC.

13) DECKS. Deck railing must be iron or wood that is treated and stained. Final sizes and materials can vary with DRC approval.

14) DOG HOUSES, DOG RUNS, and DOG COURTYARDS. Materials, colors, and location must be approved by the DRC. Must be located in the rear of the house as an integral part of the deck, patio area, side, or rear landscaping. Dog Runs may not exceed 100 square feet and they are not to be the primary living quarters for the pet. At least one side of the enclosure must be the home itself. Must be installed in such a way that they do not create the potential for noise disturbance or other nuisance for adjacent property owners. Dog Houses may not be located outside of a dog run.

15) DRAINAGE. There can be no interference with or change to the established drainage pattern over the property. When landscaping is installed, it is very important to insure that water drains away from foundations, sidewalks, and driveways, and that the flow patterns prevent water from flowing under or ponding near or against foundations, sidewalks, and driveways. Changing drainage patterns so that adjoining lots are adversely impacted is not permitted. Final lot grading must comply with the overall development grading plans as they have been approved, i.e. it is not permitted to make a garden-level lot out of a "B" lot, etc. Contact the DRC for lot specific top-of-foundation elevations. The builder must provide a copy of the Grade Certification to the DRC upon issuance of a Certificate of Occupancy.

16) DRIVEWAYS. Extension or expansion of driveways requires DRC approval. All driveways shall be constructed entirely of concrete, stamped and/or colored concrete, brick, or pavers from the entrance of the garage doors to the existing street. Colors must be approved by the DRC.

17) FLAGPOLES. One wall-mounted bracket (painted as required) per residence shall be allowed. Free standing flag poles are not allowed. Only American Flags, Flags of a United States State, and United States Military Service Flags are permitted. Flags must be displayed according to the Federal Flag Code.

18) GARBAGE COLLECTION and CONTAINERS. At the discretion of the HOA, one single trash collection company may be permitted to pick up trash in Trailside. All homeowners must use uniform container designated by said company and place these containers outside only on the day they will be emptied. All containers must be moved back inside the same day, after they are emptied. This procedure limits garbage trucks to one day per week, thereby increasing safety, reducing wear and tear on the streets, reducing noise, and allowing for discount pricing. Other than time of pick up, garbage containers must be stored indoors at all times.

19) GARDENS. Type and location require DRC approval. Container gardens over 25 inch size or 20 gallons must be approved by the DRC. Placement of gardens on turf must be approved regardless of size.

20) GREENHOUSES. Type and location require DRC approval.

21) HARD SURFACING. Type and location require DRC approval regardless of whether for walks, driveways, porches, patio areas, or other purposes and regardless of whether concrete, asphalt, brick, flagstones, stepping stones, or paver stones are used as the hard surfacing material. Hard surfaces must be located so as not to block any drainage patterns.

22) HOT TUBS. Must be an integral part of the deck or patio area and of the rear or side yard landscaping. Must be installed in such a way that it is not immediately visible to adjacent property owners and does not create the potential for noise disturbance for adjacent property owners. Must be installed in a location closer the home than the property line. Hot tubs may be excluded in certain neighborhoods.

23) HOUSE NUMBERS: House numbers shall be a minimum of 5 inches high, pressed in, and black.

24) IRRIGATION SYSTEMS. See "SPRINKLER SYSTEMS".

25) LANDSCAPING. Design shall be prepared by a professional landscape designer. Landscaping shall be installed as soon as weather permits, but in any event no later than 6 months after a Certificate of Occupancy is issued. DRC approval is required for yard art and sculptures.

- 26) LATTICEWORK. Type and location require DRC approval.
- 27) LIGHTS and LIGHTING. Exterior and landscape lighting shall be of a conventional style with illumination patterns and intensities which do not create a nuisance for adjacent property owners.
- 28) OUTDOOR FURNISHINGS. Only furnishings manufactured specifically for outdoor use are permitted on decks, patios, porches, or in yards. Furnishings intended for indoor use are prohibited. No objects other than outdoor furnishings, planters, and pot for plants may be placed on decks, patios, porches or in yards. Items including, but not limited to, exercise equipment, bicycles, skis, portable basketball hoops, and other temporary use play equipment must be stored inside when not in use.
- 29) PAINTING. All residences, accessory buildings, storage buildings, playhouses, and play equipment shall be kept well-painted in the color originally approved by the DRC. Color changes must be approved by the DRC.
- 30) PATIO COVERS. Type and location require DRC approval. Covers must be constructed of wood or a material that is generally recognized as complementary to the residence. They must be similar or complementary to the exterior color of the residence. They should look like an integral part of the residence, rather than "tacked on" or an "after thought". Posts supporting patio covers must complement the architecture of the house.
- 31) PATIOS (OPEN). Type and location require DRC approval. Patios must be an integral part of the residence and/or landscaping. They must be similar to and complementary in color and design to the design of the residence. They must be located so as to not create the potential for noise disturbance for adjacent property owners, and they must not block any drainage patterns.
- 32) PAVING. See "HARD SURFACING".
- 33) PLAY, SPORTS EQUIPMENT, AND SPORTS COURTS. Type and location require DRC approval. All canopies and coverings for play equipment and swings must be earth tones or compatible with the colors of the exterior of the home. No bright colors will be permitted. No portion of any play equipment may exceed 8 feet in height. No play equipment may be closer to a property line than the side yard setback distance. All play equipment must be constructed of wood and stained to match the standard wooden fence or it must be painted to match the house. Play equipment should be incorporated into the landscape and at least partially screened by landscaping features so as to not create the potential for noise disturbance for adjacent property owners. Basketball hoops may exceed 8 feet in height. Trampolines and sports courts shall be placed a minimum of 5-feet (5') from all property lines in the rear and side yard. Sport courts cannot be over 50% of the total area of the rear or side yard. Sport courts cannot be used for regular routine group practice and cannot create a disturbance to the community.
- 34) PLAY HOUSES. Type and location require DRC approval. In general, they are to be less than 8 feet in height at the peak and have less than 120 square feet of floor space. Basic design, materials and colors must be similar or complementary to the residence. Playhouses should be incorporated into the landscape and at least partially screened by landscaping features so as to not create the potential for noise disturbance for adjacent property owners.

35) POOLS. Only in-ground or indoor pools are allowed. Above-ground swimming pools are not permitted. DRC approval is required.

36) RETAINING WALLS. Type, materials, and location require DRC approval. Retaining walls must not block any drainage patterns. Retaining walls that change drainage patterns so that adjoining lots are adversely impacted are not permitted. It must be similar in appearance and color to the stone or masonry on the residence.

37) SATELLITE DISHES. Microwave, internet, and/or satellite television dishes are permitted on side and rear elevations only. Location must be approved by DRC prior to installation. Maximum diameter of dish is forty (40) inches. There may be a maximum of one (1) dishes per property.

38) SAUNAS. See "ADDITIONS and EXPANSIONS".

39) SEMI-PRIVATE SCREEN FENCE may be used in a limited context to screen portions of the back yard around hot tubs or other private design elements. In all cases, the Semi-Private Screen Fence may be used for no more than 50% of the linear footage of each rear- or sideyard property line, sideyards being measured from the rear property line to the middle point of side of the home adjacent to the side property line in question. When used to screen a hot tub or other private design element, the Semi-Private Screen Fence may not extend more than 10' from outer edge of the hot tub or design element. When used on a private lot, the Semi-Private Screen Fence may not be used on property lines abutting open space or tracts, except when abutting an alley. Use of the Semi-Private Screen Fence within open space or tracts managed by the HOA is at the discretion of the DRC and/or HOA. Fence must be installed to match the horizontal wood fence design as shown in section 5.1.1.

40) SEASONAL DECORATIONS. Christmas decorations shall not be displayed prior to Thanksgiving and must be removed By January 10 of the following year. Other holiday decorations should be removed within one week after the celebrated holiday. No decorations shall be displayed in such a manner as to be offensive to the neighborhood or create a public nuisance.

41) SIGNS. DRC approval is required for all signs, including address numbers and nameplates. One temporary real estate "for sale" sign (per lot) does not require DRC approval, provided it is not more than 5 square feet in size. Political signs that carry a message intended to influence the outcome of an election, including supporting or opposing the election of a candidate, the recall of a public official, or the passage of a ballot issue may be displayed no earlier than 45 days prior to election day and must be removed no later than 7 days after an election. One political sign per political office or ballot issue with a dimension no greater than 3 feet by 4 feet is allowed and does not need DRC approval. If local ordinances are more restrictive than these guidelines, then local ordinances apply. Lighted signs of any kind are not permitted.

42) SOLAR ENERGY DEVICES. All passive and active solar systems require DRC approval. They must be designed to appear as if they are an integral part of the residence. No exterior plumbing may be visible.

43) SPRINKLER SYSTEMS. All yards must have an automatic, clock-activated, buried sprinkler system throughout the entire lot.

44) SWING SETS. (See Play and Sports Equipment) Type and location require DRC approval.

45) TRASH CONTAINERS AND ENCLOSURES. See "GARBAGE COLLECTION and CONTAINERS".

46) VENTS. All wall vents including, but not limited to, dryers, cook-tops, range hoods, bathroom exhaust fans, gas fireplaces, and plumbing must be screened from sight, preferably on the rear elevation, and painted to match the permanent residence color or trim color, whichever lessens the visual impact.

47) WIND CHIMES: Installation of Wind Chimes will require DRC approval. The Committee will consider the number of wind chimes present and the location when determining approval. It will be within the authority of the Committee to rescind approval of any/all wind chimes if a nuisance is created.

The following items are NOT PERMITTED under any circumstances:

- 1) EVAPORATIVE COOLERS.
- 2) GROOVED AND/OR T-111 PANELIZED SIDING.
- 3) PERMANENT EXTERIOR DECORATIONS.
- 4) RADIO ANTENNAE.
- 5) ROOFTOP EQUIPMENT (OTHER THAN SOLAR COLLECTION EQUIPMENT AS ALLOWED BY LAW).
- 6) STORAGE TANKS.
- 7) STUCCO BOARD.
- 8) SWAMP COOLERS.
- 9) TELEVISION ANTENNAE.
- 10) TEMPORARY STRUCTURES.
- 11) WELLS.

4.0 LANDSCAPE STANDARDS:

4.1 PUBLIC / OPEN SPACE LANDSCAPE

The Trailside Metro District will be in charge of all public open spaces. The District will maintain irrigation lines for common areas, be responsible for snow removal on trails in the defined common area, pool and maintenance thereof, common trash receptacle removal, insurance for the aforementioned items, maintenance of the fences constructed in the common area, as well as maintenance of monumentation signage.



4.1.1 PARKS

Two centrally-located larger neighborhood parks provides recreation opportunities for the residents of Trailside. The parks will be owned, built, operated, and maintained by the District and will include a variety of active and passive elements. A series of District owned pocket parks will be located throughout the community.

4.1.2 ENTRYWAYS & EDGES

In addition to final monumentation, the entryway and edge landscape treatments at Trailside establish the character and theming of the neighborhood. Design elements include enhanced naturalized planting beds, berming, and a variety of deciduous trees, evergreen trees, ornamental trees, deciduous and evergreen shrubs, and annuals. The design for these areas is included in the Final Plat Landscape Plan.

4.1.3 TRAIL CORRIDORS

Trail corridors are provided throughout Trailside and include native seed, open rail fencing, evergreen trees, deciduous trees, and other landscaping. The District is responsible for maintaining these trails.

4.2 PRIVATE LANDSCAPE

1. The location of trees and shrubs must be carefully planned so that mature sizes do not interfere with fences, landscaping, or structures on adjacent lots.
2. Front yard landscaping should create a cohesive “flowing” relationship between adjacent lots.
3. Front yard and side yard landscaping along all streets shall extend to the back of curb at street, including within the street Right of Way behind curb line.
4. Trees, shrubs, and planting beds should blend together between adjacent lots for a pleasing streetscape.
5. Planting beds between adjacent lots should appear unified by using the same type of rock or wood mulch.
6. Avoid designs with formal plantings, hard edges, mow curbs, or other materials that delineate lot lines.
7. Landscaping adjacent to native open spaces should blend and harmonize with the natural landscape.
8. Retaining walls should be low, visually attractive, and made of natural materials to complement the architectural style of the home. They should generally blend with the masonry used on the home and should appear to be a “natural outcropping”.
9. Garages, parking areas, driveways, utility boxes, trash enclosures, pet enclosures, play equipment, gardens, pools, tennis courts, hot tubs, etc., shall be screened from adjoining residences and streets.
10. Final tree placement is subject to required setbacks from utilities, light poles, and signs. Refer to Final Plat Landscape Plan for homebuilder approximate tree lawn tree placement location.

4.2.1 GENERAL LANDSCAPE REQUIREMENTS

1. All front yards shall be completely landscaped with planting beds and drought tolerant bluegrass turf. Rear yards shall be landscaped with planting beds and bluegrass turf. Water conservation is encouraged by utilizing grasses that require significantly less water or considering a xeriscape design. Xeriscape meaning installing a smaller turf area, utilizing low-water plants, using soil amendments and mulches, and irrigating efficiently.
2. Landscape plans shall be designed by a professional landscape designer / architect.
3. Landscaping shall be installed as soon as weather permits, but in any event no later than 6 months after a Certificate of Occupancy is issued.
4. Buried sprinkler systems must be installed in front, side, and backyards. All plant material shall be irrigated.
5. Trees shall be minimum 2" caliper and shrubs shall be minimum 5 gallon.
6. Turf shall be a high quality drought tolerant bluegrass or an approved drought tolerant fescue.
7. Artificial turf may be considered inside and rear yards but not areas visible from public streets. The design intent is for artificial turf to emulate natural grass. See Artificial Turf Standards pg. 19
8. Additional lot configurations and home types are permitted in the PDO beyond those whose landscape standards are shown below. Should additional housing product be proposed that is not addressed by the below standards, landscape standards will be determined by the DRC and shall have a character consistent with the standards within this document.



LANDSCAPING- ARTIFICIAL TURF

Artificial turf may be considered inside and rear yards but not areas visible from public streets. The design intent is for artificial turf to emulate natural grass. Please state the intended use of the turf on the application. If selecting one of the pre-approved artificial turf brands listed below, please submit the manufacturer cut sheet or informational sheet with the application. If a pre-approved artificial turf is not being proposed, the application must include a physical sample of the proposed material showing the color and pile height along with a manufacturer cut sheet or informational sheet.

Allowable Products

The color must be similar to the geographical area, preferably a blended, multi-color monofilament fiber. There are certain products that have been pre-approved by the DRC as meeting the requirements of these Guidelines. The pre-approved brands are listed below.

Allowable Products Continued

Easy Turf – Ultimate Natural Artificial Turf 2" height.

Easy Turf – Pedigree 1 1/2" height.

Next 2 Natural – Natural Envy 2" height.

Next 2 Natural – Sense 2" height.

Mile High Synthetic Turf – Colorado Blend Pro 2" height.

Mile High Synthetic Turf – Colorado Blend King 2 3/8" height.

Purchase Green – Arizona Platinum Olive 2" height.

Purchase Green – Arizona Platinum Spring 2" height.

Installation Considerations:

Professional installation is required and must include a weed barrier and a porous, aggregate road base for drainage.

Proper infill for residential application, such as a silica sand or "Envirofill" for kid and pet areas must be used. If only for a pet use area, a product with less secondary thatch may be used. Infill must not be toxic to humans or pets and must blend into the turf and not be visually distracting.

The established drainage pattern may not be blocked or altered by the installation of artificial turf.

A weed suppressor must be used under seams and the seams must be properly secured.

If an artificial turf area will meet an area where native landscaping has been established, it must be separated by a barrier of at least four (4) inches of hardscape or planting area.

Maintenance Considerations

Artificial must be cleaned as necessary and periodically groomed to maintain its appearance. The District reserves the right to inspect and require replacement after the life expectancy has been reached, typically 15 to 20 years, or if the turf is not maintained in good condition

4.3 SIDE YARD USE EASEMENTS

Side yard use easements may occur from front property line to rear property line on the single family detached ally-loaded lots. Refer to the approved PDO for specific information.

In general, Side Yard Use Easements function as shown below:

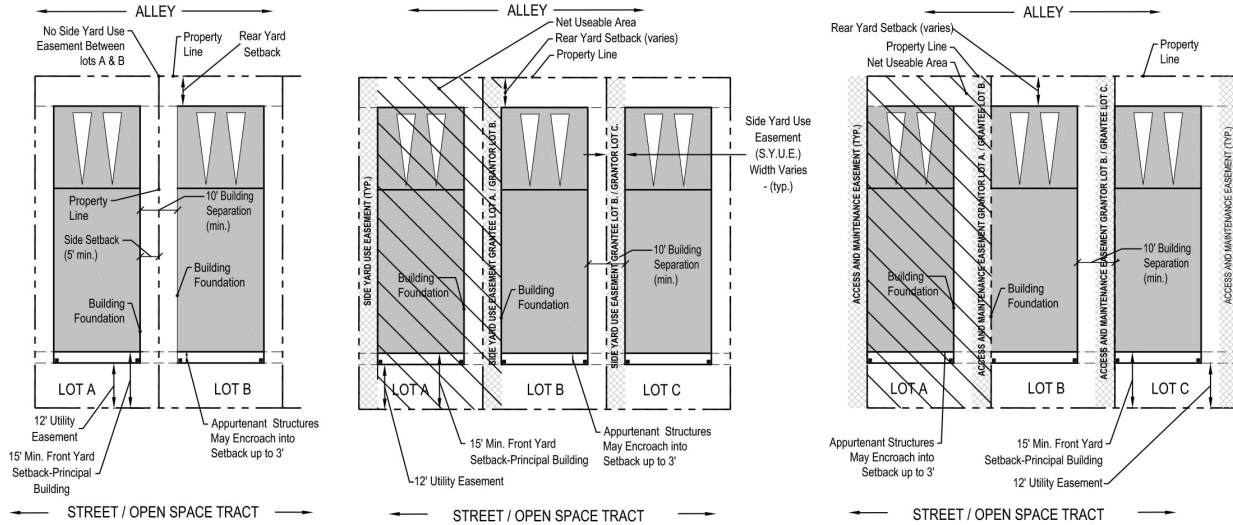

Standard Lots without Side Yard Use Easements

Standard Lots with Side Yard Use Easements

Standard Lots with Zero Lot Lines

INSTALLATION AND MAINTENANCE REQUIREMENTS

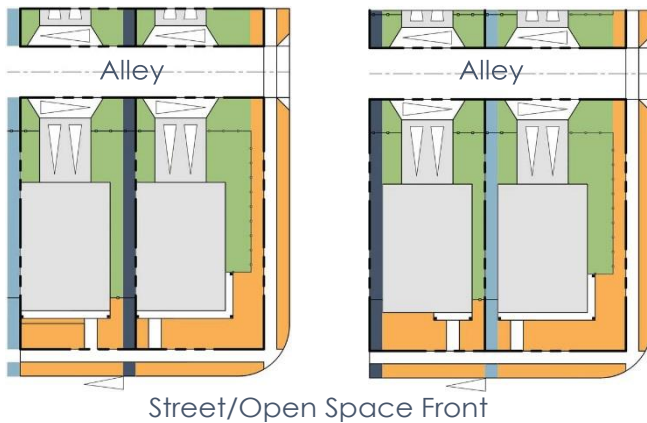

- Property Line
- 3-Rail Fencing
- Horizontal Fence
- Orange Landscape installed by Builder and maintained by homeowner or sub-association
- Green Landscaping installed by homeowner or builder and maintained by homeowner
- Blue Side Yard Use Easement: Grantee
- Dark Blue Side Yard Use Easement: Grantor

DESIGN GUIDELINES

4.4 LANDSCAPE LOT TYPICALS, MAINTENANCE, AND REQUIRED PLANTING

4.4.1 SINGLE FAMILY DETACHED FRONT LOAD/SIDE LOAD

INSTALLATION AND MAINTENANCE REQUIREMENTS

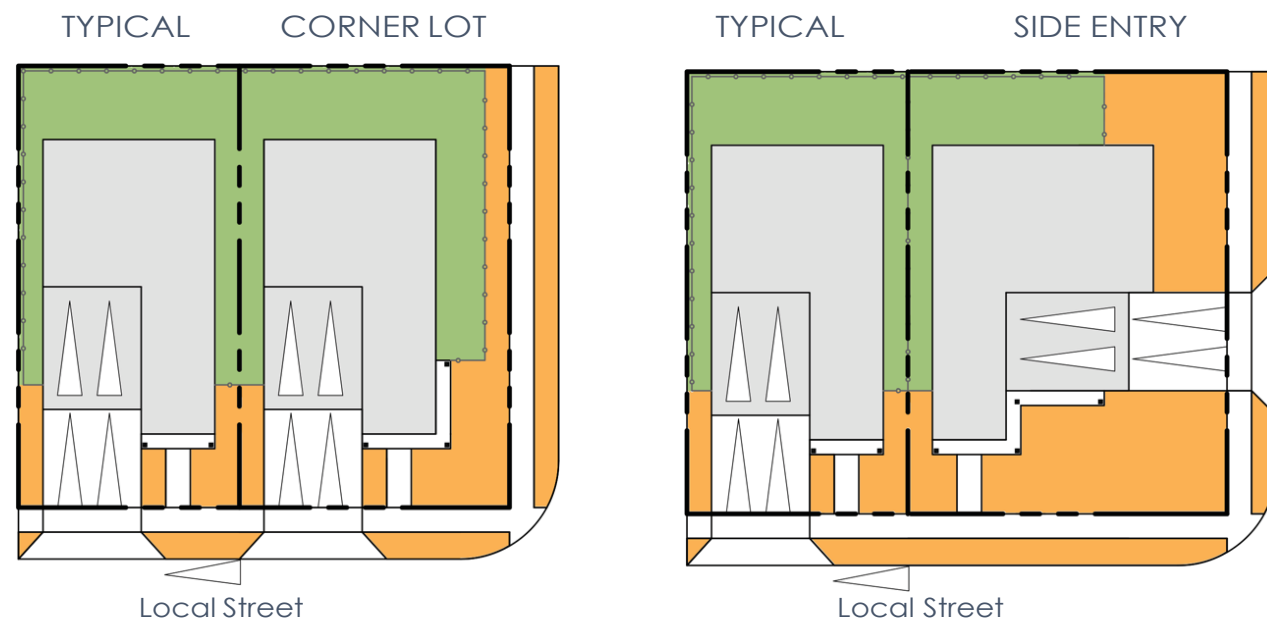

- Property Line
- 3-Rail Fencing
- — — Horizontal Fence
- Orange Landscape installed by Builder and maintained by homeowner or sub-association
- Green Landscaping installed by homeowner or builder and maintained by homeowner

REQUIRED PLANTING AND TYPICAL LOT PLANTING DESIGN

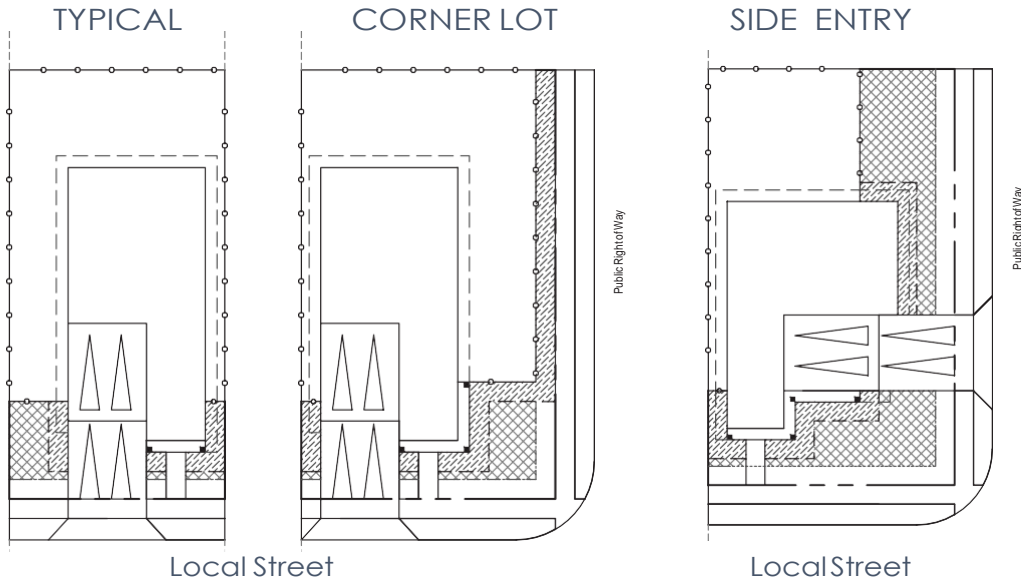

Minimum Required Quantities By Lot Type and Location

Material	Typical Lot		Corner Lot		Side Entry	
	Front Yard	Side Yard	Front Yard	Side Yard	Front Yard	Side Yard
Ornamental Tree or Sm. Evergreen Tree	0	1	0	1	0	0
Evergreen Shrubs	1	3	1	3	1	3
Deciduous Shrubs/ Ornamental Grasses/ Perennials	5	5	5	5	5	5

*The Street Tree required by the Town of Timnath meets the requirement for the Front Yard Tree

Notes:

1. Turf may have undulating form. Turf and bed line should meet adjacent home turf and bed lines when possible. The required five (5) foot wide turf and five (5) foot wide planting strip should be intermittently exceeded to provide planting variation. Where dimensions for five feet of turf and five feet of planting bed are less than ten (10) feet, plant only planting bed and no turf.
2. Maintain three (3) foot no irrigation zone around principal structure per geotechnical recommendations. Required five (5) foot planting bed does not include 3-foot no irrigation zone.
3. Flex zone allows homeowner to choose to expand either turf or planting bed areas.
4. Side yard incorporates area adjacent to side fencing and must meet a minimum of 80% coverage of live landscape material at least three (3) feet in height.
5. A diversity of plant types must be incorporated in all planting beds. No more than 25% of the same species of live shrubs, ornamental grasses, or perennials, shall be planted.
6. Variations from required planting may be approved by the Design Review Committee on an individual basis.

4.4.2 SINGLE FAMILY DETACHED FRONT LOAD/PASS-BY

INSTALLATION AND MAINTENANCE REQUIREMENTS

PASS-BY: TYPICAL LOTS

CORNER LOT

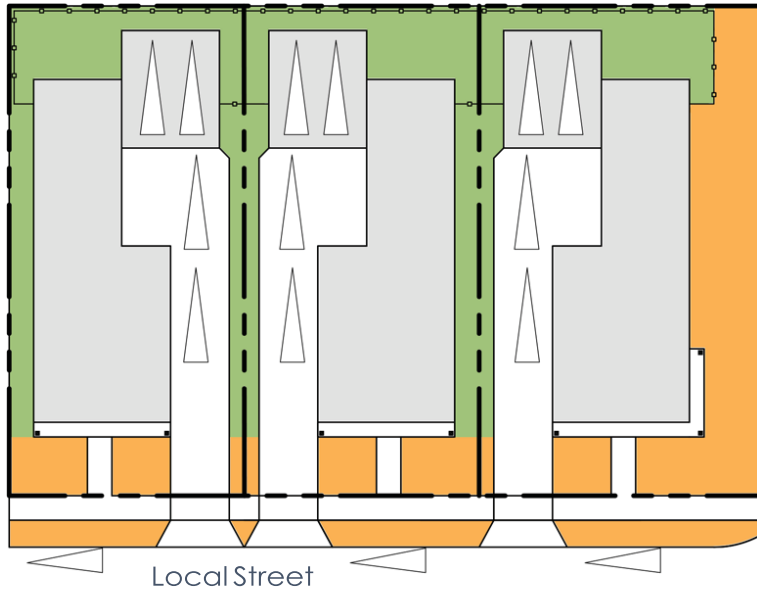

- Property Line
- - - - - 3-Rail Fencing
- - - - - Horizontal Fence
- Orange Landscape installed by Builder and maintained by homeowner or sub-association
- Green Landscaping installed by homeowner or builder and maintained by homeowner

REQUIRED PLANTING AND TYPICAL LOT PLANTING DESIGN

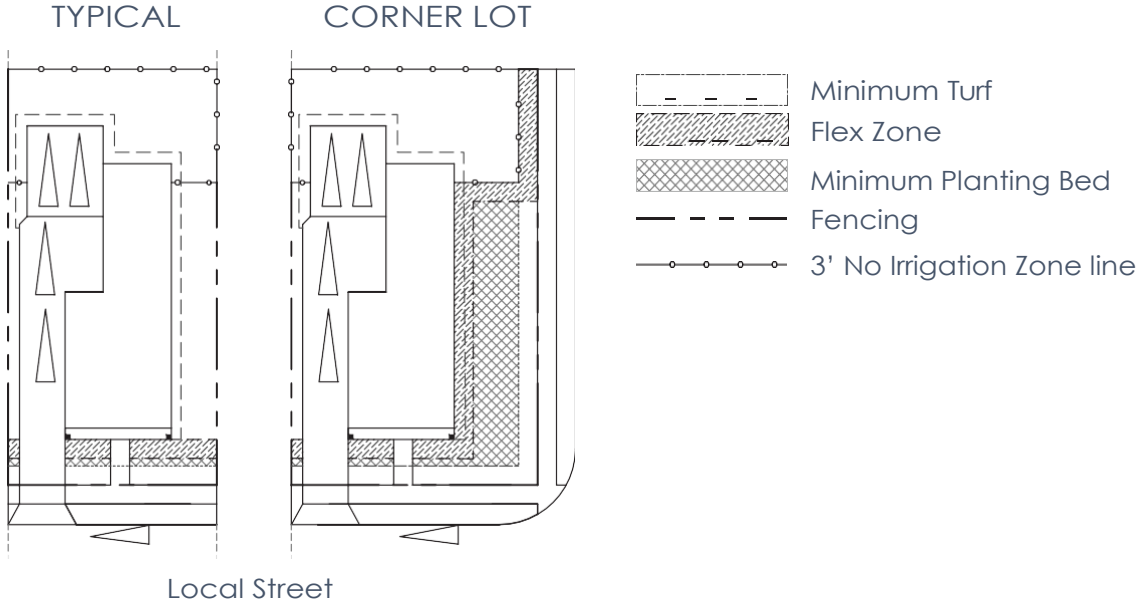

Minimum Required Quantities By Lot Type and Location			
Material	Typical Lot	Corner Lot	
	Front Yard	Front Yard	Side Yard
Ornamental Tree or Sm. Evergreen Tree	0*	1	0
Evergreen Shrubs	1	1	3
Deciduous Shrubs/ Ornamental Grasses/ Perennials	12	12	16

*The Street Tree required by the Town of Timnath meets the requirement for the Front Yard Tree

Notes:

1. Turf may have undulating form. Turf and bed line should meet adjacent home turf and bed lines when possible. The required five (5) foot wide turf and five (5) foot wide planting strip should be intermittently exceeded to provide planting variation. Where dimensions for five feet of turf and five feet of planting bed are less than ten (10) feet, plant only planting bed and no turf.
2. Maintain three (3) foot no irrigation zone around principal structure per geotechnical recommendations. Required five (5) foot planting bed does not include 3-foot no irrigation zone.
3. Flex zone allows homeowner to choose to expand either turf or planting bed areas.
4. Side yard incorporates area adjacent to side fencing and must meet a minimum of 80% coverage of live landscape material at least three (3) feet in height.
5. A diversity of plant types must be incorporated in all planting beds. No more than 25% of the same species of live shrubs, ornamental grasses, or perennials, shall be planted.
6. Variations from required planting may be approved by the Design Review Committee on an individual basis.

4.4.3 SINGLE FAMILY DETACHED REAR-LOAD

INSTALLATION AND MAINTENANCE REQUIREMENTS

TYPICAL

CORNER LOT

GREENCOURT

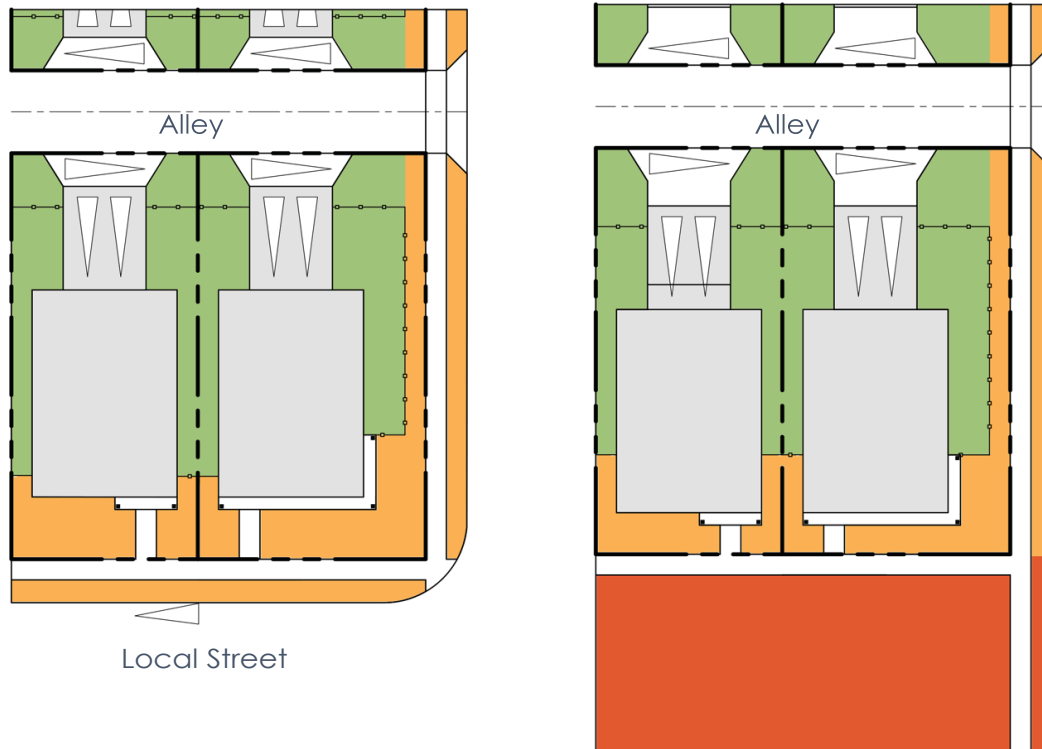

- Property Line
- - - 3-Rail Fencing
- - - Horizontal Fence
- Landscape installed by District or Builder and maintained by District
- Landscape installed by Builder and maintained by homeowner or sub-association
- Landscaping installed by homeowner or builder and maintained by homeowner

REQUIRED PLANTING AND TYPICAL LOT PLANTING DESIGN

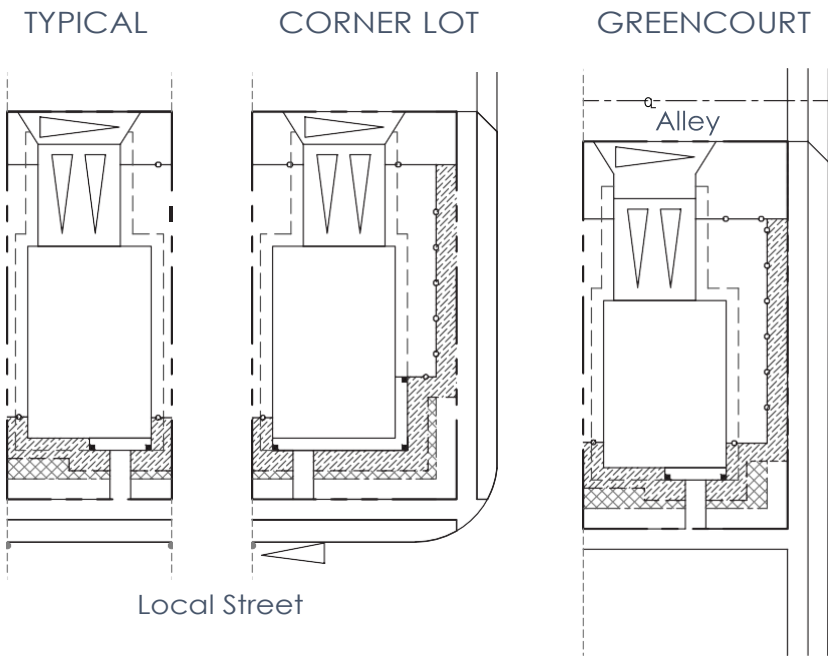

- Minimum Turf
- Flex Zone
- Minimum Planting Bed
- Fencing
- 3' No Irrigation Zone line

Material	Minimum	Required Quantities By		Lot Type and Location	
	Typical Lot	Corner Lot		Lot Adjacent to Greencourt	
	Front Yard	Front Yard	Side Yard	Front Yard	Side Yard
Ornamental Tree or Sm. Evergreen Tree	0*	0*	0	1	0
Evergreen Shrubs	1	1	3	3	3
Deciduous Shrubs/ Ornamental Grasses/ Perennials	5	5	5	5	5

*The Street Tree required by the Town of Timnath meets the requirement for the Front Yard Tree

Notes:

1. Turf may have undulating form. Turf and bed line should meet adjacent home turf and bed lines when possible. The required five (5) foot wide turf and five (5) foot wide planting strip should be intermittently exceeded to provide planting variation. Where dimensions for five feet of turf and five feet of planting bed are less than ten (10) feet, plant only planting bed and no turf.
2. Maintain three (3) foot no irrigation zone around principal structure per geotechnical recommendations. Required five (5) foot planting bed does not include 3-foot no irrigation zone.
3. Flex zone allows homeowner to choose to expand either turf or planting bed areas.
4. Side yard incorporates area adjacent to side fencing and must meet a minimum of 80% coverage of live landscape material at least three (3) feet in height.
5. A diversity of plant types must be incorporated in all planting beds. No more than 25% of the same species of live shrubs, ornamental grasses, or perennials, shall be planted.
6. Variations from required planting may be approved by the Design Review Committee on an individual basis.

4.4.4 FRONT LOAD PAIRED HOMES

INSTALLATION AND MAINTENANCE REQUIREMENTS

TYPICAL CORNER

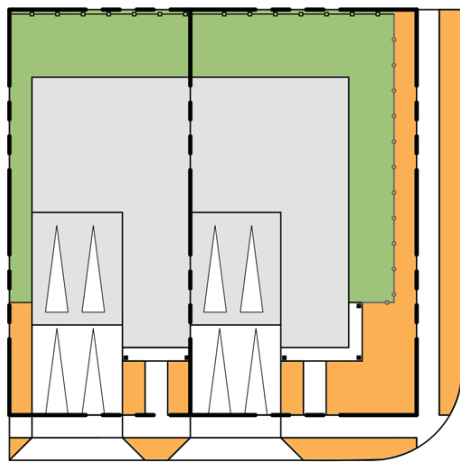

Local Street

TYPICAL SIDE ENTRY

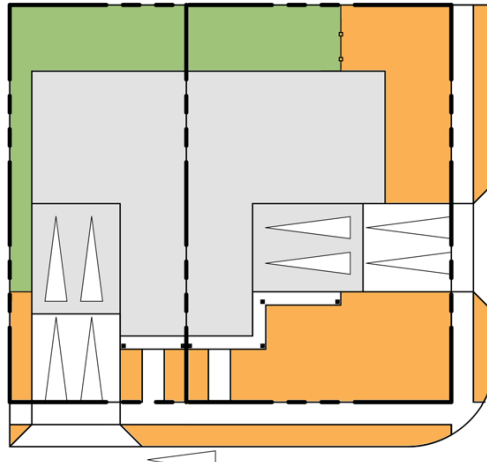

Local Street

- Property Line
- 3-Rail Fencing
- Horizontal Fence
- Orange Landscape installed by Builder and maintained by homeowner or sub-association
- Green Landscaping installed by homeowner or builder and maintained by homeowner

REQUIRED PLANTING AND TYPICAL LOT PLANTING DESIGN

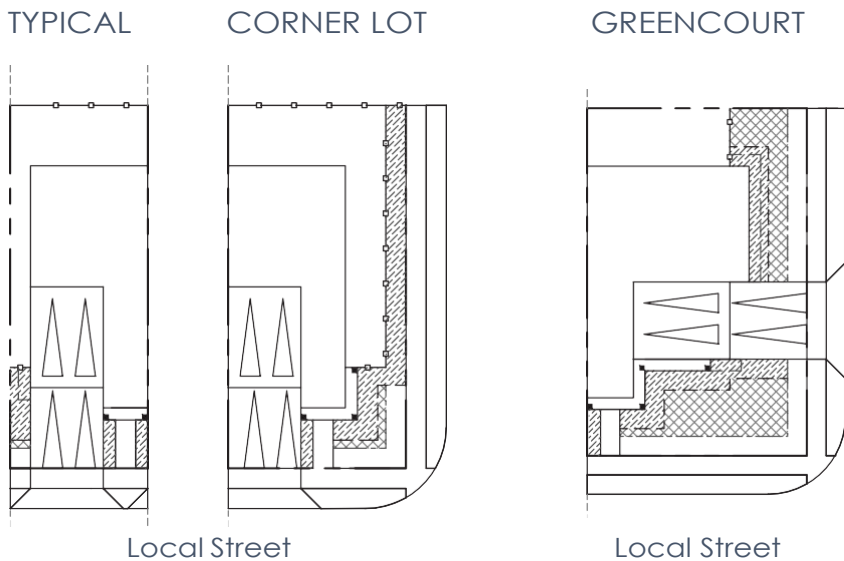

Material	Minimum Required Quantities By Lot Type and Location				
	Typical Lot	Corner Lot		Side Entry	
	Front Yard	Front Yard	Side Yard	Front Yard	Side Yard
Ornamental Tree or Sm. Evergreen Tree	0*	0*	0	1	0
Evergreen Shrubs	1	1	3	1	3
Deciduous Shrubs/ Ornamental Grasses/ Perennials	5	5	5	5	5

*The Street Tree required by the Town of Timnath meets the requirement for the Front Yard Tree

Notes:

1. Turf may have undulating form. Turf and bed line should meet adjacent home turf and bed lines when possible. The required five (5) foot wide turf and five (5) foot wide planting strip should be intermittently exceeded to provide planting variation. Where dimensions for five feet of turf and five feet of planting bed are less than ten (10) feet, plant only planting bed and no turf.
2. Maintain three (3) foot no irrigation zone around principal structure per geotechnical recommendations. Required five (5) foot planting bed does not include 3-foot no irrigation zone.
3. Flex zone allows homeowner to choose to expand either turf or planting bed areas.
4. Side yard incorporates area adjacent to side fencing and must meet a minimum of 80% coverage of live landscape material at least three (3) feet in height.
5. A diversity of plant types must be incorporated in all planting beds. No more than 25% of the same species of live shrubs, ornamental grasses, or perennials, shall be planted.
6. Variations from required planting may be approved by the Design Review Committee on an individual basis.

4.4.5 ALLEY LOADED PAIRED HOMES





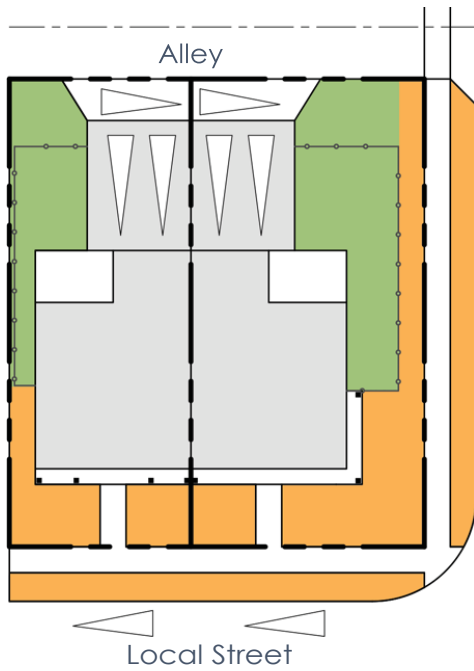

INSTALLATION AND MAINTENANCE REQUIREMENTS

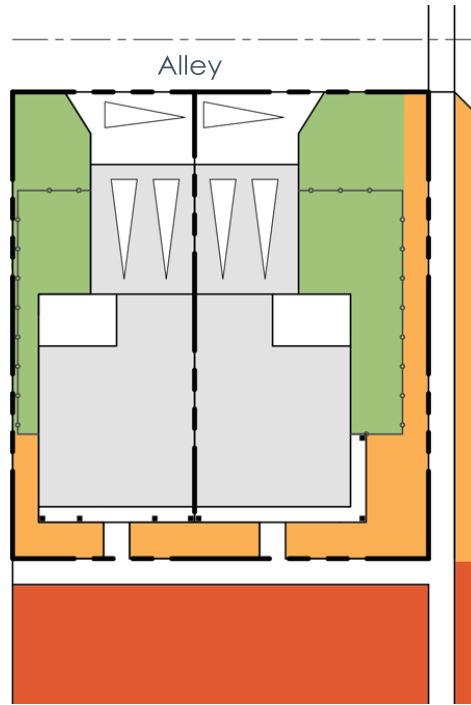
TYPICAL CORNER LOT



GREENCOURT



-  Property Line
-  3-Rail Fencing
-  Horizontal Fence
-  Landscape installed by District or Builder and maintained by District
-  Landscape installed by Builder and maintained by homeowner or sub-association
-  Landscaping installed by homeowner or builder and maintained by homeowner

REQUIRED PLANTING AND TYPICAL LOT PLANTING DESIGN

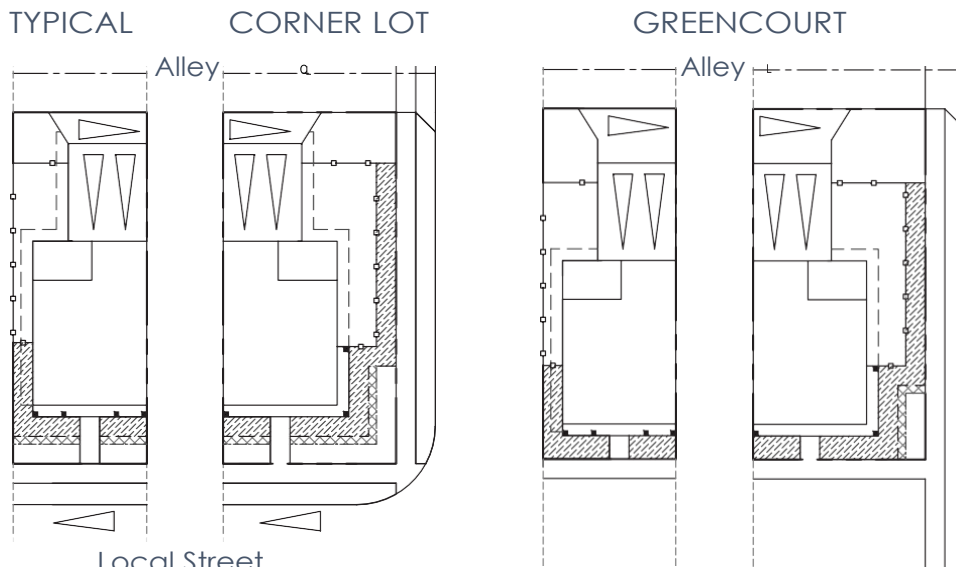

Material	Minimum Required Quantities By Lot Type and Location				
	Typical Lot	Corner Lot		Lot Adjacent to Greencourt	
	Front Yard	Front Yard	Side Yard	Front Yard	Side Yard
Ornamental Tree or Sm. Evergreen Tree	0*	0*	0	1	0
Evergreen Shrubs	1	1	4	4	3
Deciduous Shrubs/ Ornamental Grasses/ Perennials	5	5	5	5	5

*The Street Tree required by the Town of Timnath meets the requirement for the Front Yard Tree

Notes:

1. Turf may have undulating form. Turf and bed line should meet adjacent home turf and bed lines when possible. The required five (5) foot wide turf and five (5) foot wide planting strip should be intermittently exceeded to provide planting variation. Where dimensions for five feet of turf and five feet of planting bed are less than ten (10) feet, plant only planting bed and no turf.
2. Maintain three (3) foot no irrigation zone around principal structure per geotechnical recommendations. Required five (5) foot planting bed does not include 3-foot no irrigation zone.
3. Flex zone allows homeowner to choose to expand either turf or planting bed areas.
4. Side yard incorporates area adjacent to side fencing and must meet a minimum of 80% coverage of live landscape material at least three (3) feet in height.
5. A diversity of plant types must be incorporated in all planting beds. No more than 25% of the same species of live shrubs, ornamental grasses, or perennials, shall be planted.
6. Variations from required planting may be approved by the Design Review Committee on an individual basis.

4.4.6 TOWNHOMES

INSTALLATION AND MAINTENANCE REQUIREMENTS

FRONT LOAD:

REAR LOAD:

CORNER

TYPICAL

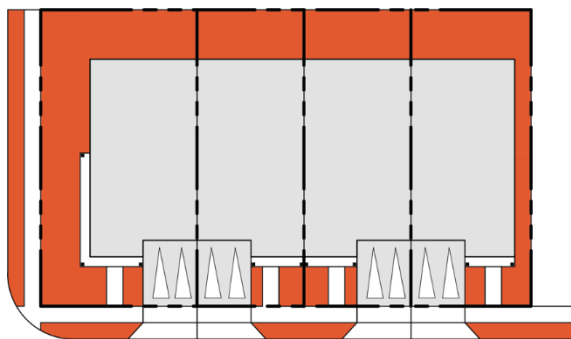

GREENCOURT

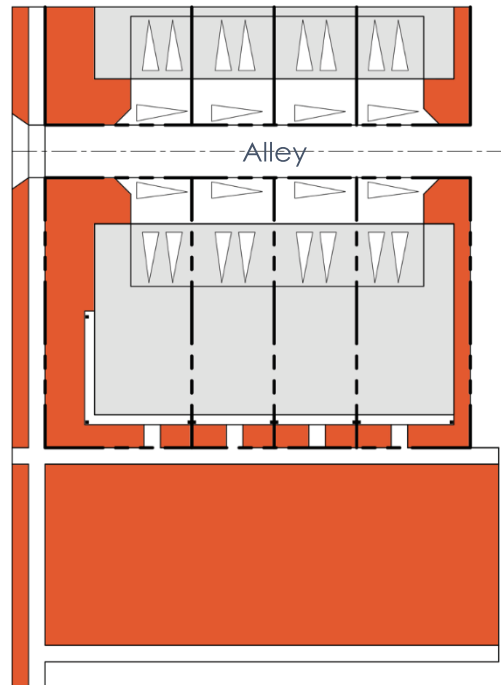
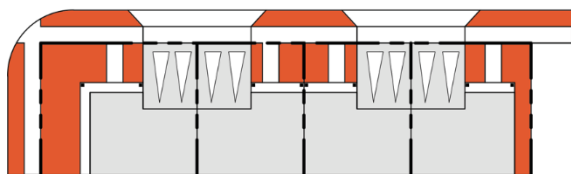

Local Street



Alley

-  Property Line
-  3-Rail Fencing
-  Horizontal Fence
-  Landscape installed by District or Builder and maintained by District

REQUIRED PLANTING AND TYPICAL LOT PLANTING DESIGN

FRONT LOAD:

REAR LOAD:

CORNER

TYPICAL

CORNER

GREENCOURT

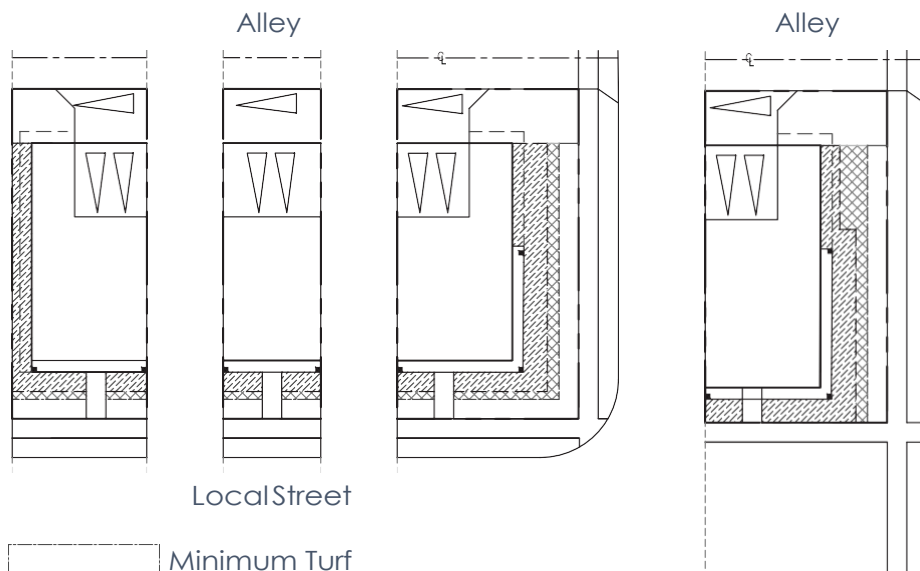

Material	Minimum Required		Quantities By Lot Type and Location		
	Front Yard	Side Yard	Typical Lot	Lot Adjacent to Greencourt	
Ornamental Tree or Sm. Evergreen Tree	0*	0*	0	1	0
Evergreen Shrubs	1	1	1	6	3
Deciduous Shrubs/ Ornamental Grasses/ Perennials	5	5	5	5	5

*The Street Tree required by the Town of Timnath meets the requirement for the Front Yard Tree

Notes:

1. Turf may have undulating form. Turf and bed line should meet adjacent home turf and bed lines when possible. The required five (5) foot wide turf and five (5) foot wide planting strip should be intermittently exceeded to provide planting variation. Where dimensions for five feet of turf and five feet of planting bed are less than ten (10) feet, plant only planting bed and no turf.
2. Maintain three (3) foot no irrigation zone around principal structure per geotechnical recommendations. Required five (5) foot planting bed does not include 3-foot no irrigation zone.
3. Flex zone allows homeowner to choose to expand either turf or planting bed areas.
4. Side yard incorporates area adjacent to side fencing and must meet a minimum of 80% coverage of live landscape material at least three (3) feet in height.
5. A diversity of plant types must be incorporated in all planting beds. No more than 25% of the same species of live shrubs, ornamental grasses, or perennials, shall be planted.
6. Variations from required planting may be approved by the Design Review Committee on an individual basis.

4.5 TRAILSIDE SIGNATURE PLANT LIST

A minimum of 50% of the species selected by the homeowner shall be made up of Trailside Signature Plants

For proper plant growth, Colorado soils shall be amended with organic material. A minimum of four cubic yards of organic material shall be added to topsoil per 1000 square feet of planting area. Organic material shall be aged compost; wood humus from soft, non-toxic trees. Proper amendments as specified will improve drainage and, as a result, conserve water. Plants will flourish and live longer, healthier lives. A soil analysis should be performed prior to planting for proper micro nutrient recommendations.

Common Name

Latin Name

Deciduous Trees

Western Catalpa	Catalpa speciosa
Swamp White Oak	Quercus bicolor
Espresso Kentucky Coffee Tree	Gymnocladus dioica 'Espresso'
Emerald Sunshine Elm	Ulmus propinqua 'JF5-Bierberich'
Imperial Honeylocust	Gleditsia triacanthos Inermis 'Imperial'
Northern Red Oak	Quercus robur
Western Hackberry	Celtis occidentalis
Japanese Pagoda Tree	Sophorica japonica

Ornamental Trees

Spring Snow Crabapple	Malus 'Spring Snow'
Prairiefire Crabapple	Malus 'Prairiefire'
Autumn Brilliance Serviceberry	Amelanchier x. grandiflora
Sucker Punch Chokecherry	Prunus virginia 'P002S'
Thornless Cockspur Hawthorn	Crataegus crus-galli 'Inermis'

Evergreen Trees

Austrian Pine	Pinus nigra
Pinon Pine	Pinus edulis
Bakeri Spruce	Picea pungens 'Bakeri'
Colorado Blue Spruce	Picea pungens

Evergreen Shrubs

Buffalo Juniper	Juniperus sabina 'Buffalo'
Globe Spruce	Picea pungens 'Globosa'
Panchito Manzanita	Arctostaphylos 'Panchito'
Slowmound Mugo Pine	Pinus mugo 'Slowmound'

Large Deciduous Shrubs

Center Glow Ninebark	Physocarpus opulifolius 'Center Glow'
Red Twig Dogwood	Cornus sericea 'Baileyi'

Common Name

Latin Name

Medium Deciduous Shrubs

Butterfly Bush
 Gro-Low Fragrant Sumac
 Pawnee Buttes Sandcherry
 Russian Sage
 Upright Red Chokecherry
 Red Prince Weigela
 Western Sand Cherry

Buddleia davidii
 Rhus aromatica 'Grow-Low'
 Prunus besseyi 'Pawnee Buttes'
 Provsikia artiplicifolia
 Aronia arbutifolia 'Erecta'
 Weigela florida 'Red Prince'
 Prunus bessyi

Small Deciduous Shrubs

Dwarf Burning Bush
 Iroquois Beauty Chokeberry
 Miss Kim Lilac
 Purple Haze Butterflybush
 Carefree Sunshine Rose
 Standing Ovation Serviceberry

Euonymus alatus 'Compacta'
 Aronia melanocarpa 'Morton'
 Syringa patula 'Miss Kim'
 Buddleia x. 'Purple Haze'
 Rose 'Radsun'
 Amelanchier alnifolia 'Obelisk'

Ornamental Grasses

Blue Avena Grass
 Blonde Ambition Grama Grass
 Feather Reed Grass
 Maiden Grass
 Prairie Drop Seed
 Korean Feather Reed Grass
 Mexican Feather Grass
 Pampas Grass
 Red Switch Grass

Helictotrichon sempervirens
 Bouteloua Gracilis 'Blonde Ambition'
 Calamagrostis x Acutiflora 'Karl Foerster'
 Miscanthus Sinensis 'Yakushima'
 Sporobolus Heterolepis
 Calamagrostis Brachytricha
 Nassella tenuissima
 Eianthus ravennae
 Panicum virgatum 'Shenandoah'

Perennials

Magnus Coneflower
 Yellow Columbine
 Basket of Gold
 Double Bubble Mint Hyssop
 Lamb's Ear
 Husker Red Penstamon
 Crystal River Veronica
 Turkish Veronica

Echinacea purpurea 'Magnus'
 Aquilegia chrysantha 'Denver Gold'
 Aurinia saxatilis
 Agastache cana
 Stachys bysantine 'Silver Carpet'
 Penstamon digitalis 'Husker Red'
 Veronica 'Reavis Crystal River'
 Veronica liwanensis



5.0 FENCING:

5.1 PERMITTED FENCING

Fencing at Trailside is permitted along side and rear lot lines. Fencing is also permitted generally parallel to the front property line, set back from the front plane of the home. Front yard fencing is not permitted. All fencing at Trailside shall be the fences included in this document, unless otherwise approved by the DRC. The fencing shown below is to be installed by the Builder or Homeowner and is maintained by the Homeowner, and fencing built by the District will be maintained by the District.

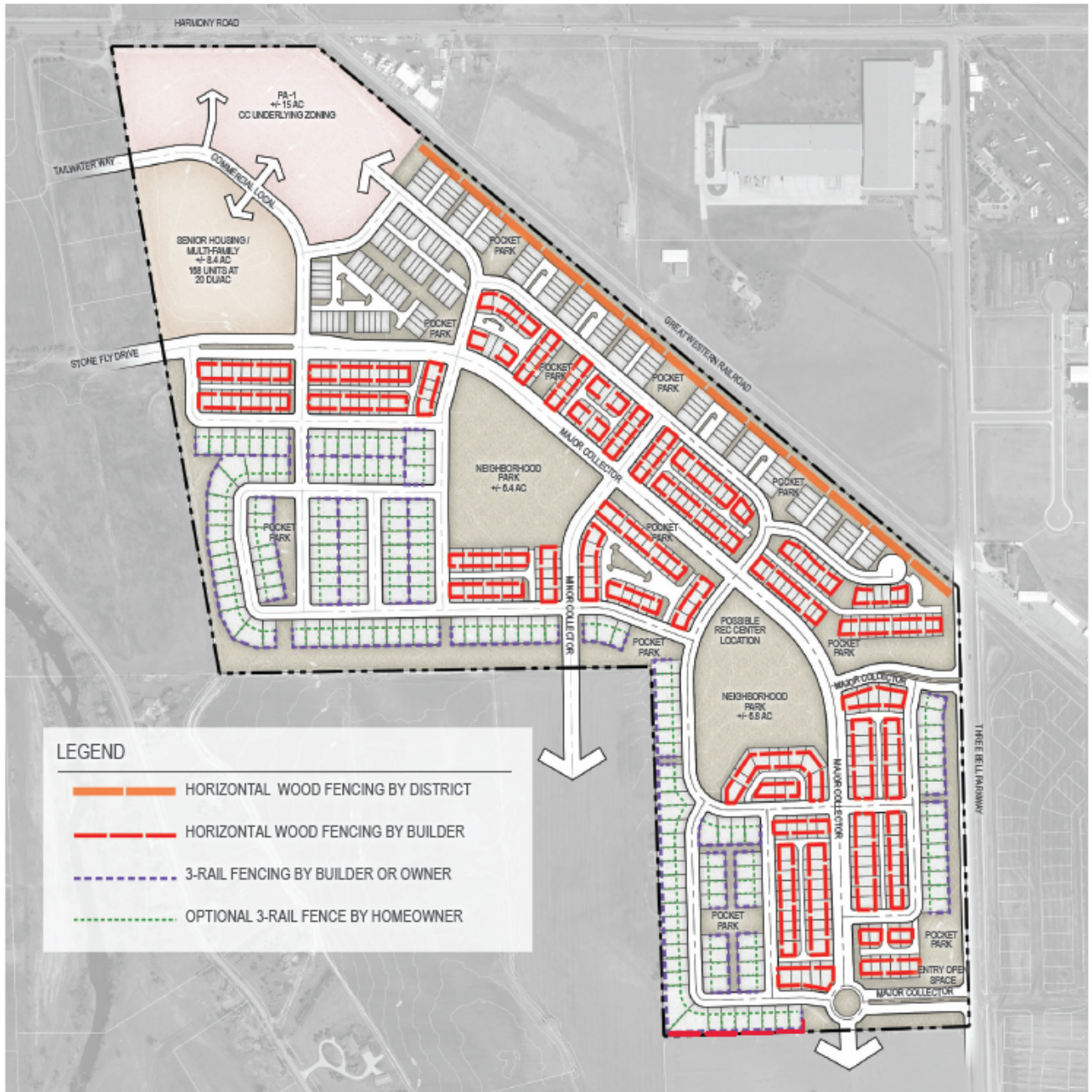

5.1.1 HORIZONTAL WOOD FENCE

The image and detail below, illustrate the Horizontal Wood Fence (Detail 1) which is for privacy fencing, screening, and will also be used for Railroad Screening.

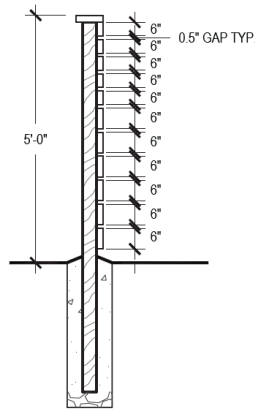
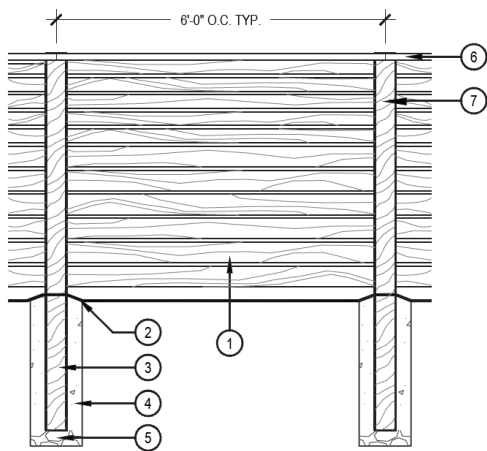

- ① 1" x 6" ROUGH SAWN CEDAR RAILS ATTACHED WITH A MINIMUM TWO WOOD SCREWS PER RAIL PER POST
- ② SLOPES AWAY FROM POST AND TROWEL SMOOTH
- ③ 4"x4"x6' ROUGH SAWN CEDAR POST
- ④ CONCRETE FOOTING
- ⑤ 4" DEPTH, 3/4" GRAVEL BASE
- ⑥ 2" x 6" ROUGH SAWN CEDAR CAP
- ⑦ 1"x4" ROUGH SAWN CEDAR RAILS ATTACHED WITH A MINIMUM TWO WOOD SCREWS PER RAIL PER POST



Detail 1

5.1.2 3-RAIL FENCE

The image and detail below, illustrate the 3-rail fence (Detail 2) which is generally for use on properties adjacent to open space and on Single Family Detached Front-Loaded homes.

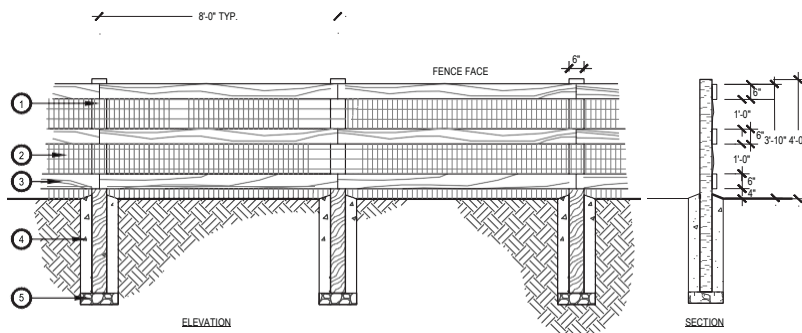

- ① 4" X 4" STAINED ROUGH SAWN CEDAR POST
- ② 4"X2" GALVANIZED WELDED WIRE MESH (12 GAUGE) 4' X 8' PANELS, SANDWICH MESH BETWEEN RAIL AND POST W/ HEAVY DUTY GAL. FASTENERS. TOP OF MESH SHALL BE LEVEL WITH TOP OF TOP RAIL
- ③ 2" X 6" STAINED ROUGH SAWN CEDAR
- ④ CONCRETE FOOTING
- ⑤ 3/4" ANGULAR ROCK - 4" DEPTH



Detail 2

5.2 FENCING SETBACKS

1. Fences shall be set back from the front plane of the principal structure a minimum of two (2) feet.
2. Where feasible, fencing in side yards parallel to the front property line on adjacent lots should generally align in order to provide a consistent and uniform appearance.
3. Fences shall be set back five (5) feet from public sidewalks.
4. Where homes side to alleys, fences shall be set back from alleys a minimum of two (2) feet. Fences shall be set back from the rear plane of the principal structure and/or garage a minimum of two (2) feet.

5.3 FENCING STAIN

1. All fences shall be stained Sherwin Williams SW2209 Tycoon Brown with the exception of the following homes.

For the following addresses 5701, 5709, 5717, 5725, 5733, 5741, 5749, 5757, 5765, 5773, 5781, 5801, 5813, 5825, 5837, 5849, 5861, 5873, 5885 Isabella Ave on the rear property line split rail fence the fence shall be stained Sherwin Williams SW3001 Shagbark.

5.4 PET AREAS

1. Where approved by the DRC, small fenced pet areas may be permitted in the single family attached and/or multi-family portions of the site.
2. No two houses in a row should have a fence.

This page intentionally left blank.

6.0 SIGNAGE:

6.1 SIGN LOCATIONS

No sign shall be erected in such a manner or location as to obstruct motorist, cyclist, or pedestrian vision, or obstruct the view of any traffic sign, signal or control device. All sign locations should be verified against approved Trailside subdivision plats and development plans to verify no utility conflicts. Should conflicts arise with any public utilities, utility locations will supersede sign locations and sign location or proportion will adjust accordingly. Verification of utility plans and field locates are required.

6.2 BUILDER SIGNAGE

Builder signs are temporary installations identifying individual home builders operating sales within the community. The Builder Sign-Sales Center, is generally intended for builder sales center identification, home marketing, or directional purposes. Builder signs shall conform to sign envelopes. Individual builders may propose their brand font and logos within the proposed sign. These signs will be located on or immediately adjacent to builder lots and sales areas. Home Builders are required to obtain Developer approval. Quantities and locations of Builder signs are at the discretion of the Developer and are permitted on Collector and local Streets.

SIGN	USE	LOCATION	SIZE
Builder Sign - Sales Center	Temporary Sign	2' from property line, min. 2' from sidewalk	Max Height: 8' Maximum sign area: sqft

MATERIALS	
1	Single Sided Vinyl Wrapped Wood Sign
2	4" Wood Post
3	Wood Frame

May be illuminated with ground mounted uplight.

6.3 BUILDER SIGN - ON SITE & MODEL HOME

Builder signs are temporary installations identifying individual home builders operating sales within the community. Builder Sign-Directional and Model Home, are smaller in scale and are intended as a part of a comprehensive builder marketing strategy and wayfinding sign collection. Builder signs shall conform to sign envelopes. Individual builders may propose their brand font and logos within the proposed sign. These signs will be located on or immediately adjacent to their lots and sales areas. Home Builders are required to obtain Developer approval. Quantities and locations of Builder signs are at the discretion of the Developer and are permitted on Collector and local Streets.

SIGN	USE	LOCATION	SIZE
Builder Sign - Directional & Model Home	Temporary Sign	2' from property line, min. 2' from sidewalk	Max Height: 4' Max sign area: 10sqft

MATERIALS	
1	Single Sided Vinyl Wrapped Wood Sign
2	Wood Post

May be illuminated with ground mounted uplight.

